

ALPHA-025

Microprocessor-Controlled Capacitor Switching Thyristor Modules
Datasheet



General Description

ALPHA-025 thyristor modules are designed for dynamic power factor correction applications requiring extremely fast and frequent switching. The modules can switch capacitive loads up to 25 kVAr typically within 10ms of receiving a triggering signal. The microprocessor-based architecture and its algorithm sense the voltage-zero crossing, thereby avoiding capacitor abrasion. The advantages of the ALPHA series modules include:

- Up to 480V, star-or delta-connected symmetrical or asymmetrical loads.
- Easy triggering from PFC relays or PLCs.
- Longer life expectancy.
- Fast switching performance – typically below 10ms.
- Guaranteed transient free capacitor switching.
- Monitors voltage, status and temperature.
- Records detected faults, provides a dry contact output and displays faults on front panel.
- Can operate with or without a detuned filter reactor.
- Provides external thermostat connection which can be used to protect detuned filter reactors.
- Maintenance free.
- Quiet operation.



ALPHA-025 Thyristor modules comply with EN 60947, IEC 60050, IEC 60085, IEC 60269, IEC 60410, IEC 60439-1, IEC 60664, IEC 60947-4-2, IEC 61000-2-1, IEC 61000-3-2, IEC 61000-4-2, IEC 61000-4-3, IEC 61000-4-4, IEC 61000-4-5, IEC 61000-4-6, IEC 61000-4-11, IEC 61131-2

Typical Application

- Welding
- Presses
- Elevators
- Cranes
- Arc Furnaces
- Wind Turbines

Operation

Module is ready to start up as soon as power and capacitor connections on L1-C1 and L3-C3 terminals are completed. When the module is turned on, it will be waiting for a trigger signal. As soon as a trigger signal is detected, the microprocessor triggers the thyristors when the voltages between their anode and cathode terminals are zero. The green status LED will light up indicating that the thyristors are triggered and the capacitors are switched on. When the trigger signal is turned off, the thyristors will cut-off through line commutation.

ALPHA modules have four LEDs on the front panel dedicated for alarms, status feedback and faults.

POWER LED (red): Informs the user that the module is powered up.

FAULT LED (red): Informs the user of internal faults. If the module detects a misconnection on L1-C1 or L3-C3 terminals, a fault on the discharge mechanism or any other error which must be cleared before the system is enabled, this LED blinks until the fault is cleared. In case of overheating (90°C), this LED will light up and stay lit until the modules are cooled below 70°C.

REACTOR FAULT DETECTION LED (red): This LED will light if reactor overheats.

STATUS LED (green): Informs the user that the modules are activated and capacitors are switched on.

Technical Specifications

Rev. 2 – 16/06/2016

Technical specifications presented here are provided for 40°C ambient temperature and 70°C heat sink temperature, unless otherwise specified. Exceeding these guaranteed ratings will significantly reduce module life expectancy.

Nominal Ratings	Units	Min.	Typ.	Max.
Operating Voltage (line-to-line)	V	380	400	480
Operating Current	A	-	-	40
Trigger Voltage	V	-	24	-
Absolute Maximum Ratings			Typ.	
Blocking Voltage	V		1600	
Current Time Rate of Change (di/dt)	A/ μ s		100	
Voltage Time Rate of Change (dV/dt)	V/ μ s		1000	
I^2t (10 ms)	A ² s		4000	
Heat sink Temperature	°C		90±5	
Ambient Temperature at Full Load	°C		40	
Ambient Temperature at 75% Load	°C		60	
Storage Temperature	°C		-40~100	
Relative Humidity	%		5~95	
Wiring and Mounting				
Power Cable Cross Section (L1,L3,C1 and C3)	mm ²		16	
Triggering Wire Cross Section	mm ²		1.5	
Dry Contact Wire Cross Section	mm ²		1.5	
External Thermostat Wire Cross Section	mm ²		1.5	
Size (W x H x D)	mm		158x154x115	
IP Class	-		20	
Weight	kg		2.2	
Operation				
Switching Time	-		Less than 10 ms	
Repetitive-switching Time	-		See Figure 5	
Max. Capacitor Power	-		See Table 1	
Power Loss	W		75	
Fault Display	-		Through 4 LEDs	
Overheating Fault Temperature	°C		90±5	
Superfast Fuse Current Rating	A		63 (NH AC 690)	

In point welding and similar applications where capacitors are required to be switched on and off frequently, the continuous ratings may be slightly extended depending on the duty and period of the operating cycle. In Figure 1 a generic intermittent duty operation is illustrated. If this is the case, the users are recommended to see Figure 3 to determine physical short term limitations of ALPHA modules. Figure 3 presents maximum allowed RMS current in relation with the duty cycle in percent (Eq. 1) for operating periods of 100ms, 1s, 10s and 1 min.

$$Duty\ Cycle\ (\%) = \frac{On\ Time}{Period} \times 100 \quad (1)$$

To allow for such operation, high powered discharge resistors or discharge reactors are mandatory to assure that the capacitors are discharged enough to be switched again safely.

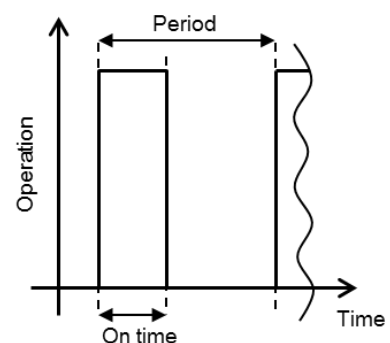

Figure 1: Intermittent Operation

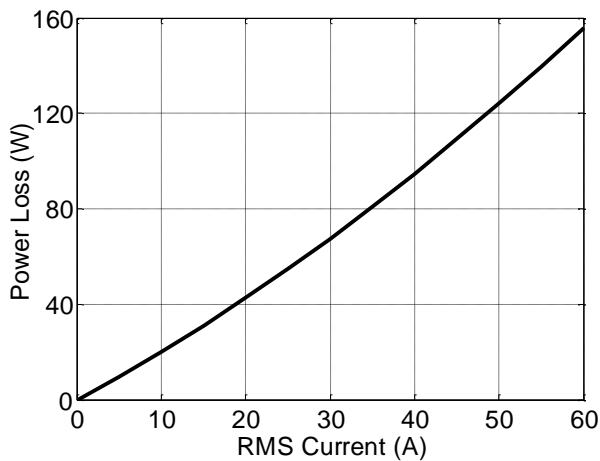

Figure 2: Power loss vs. RMS current

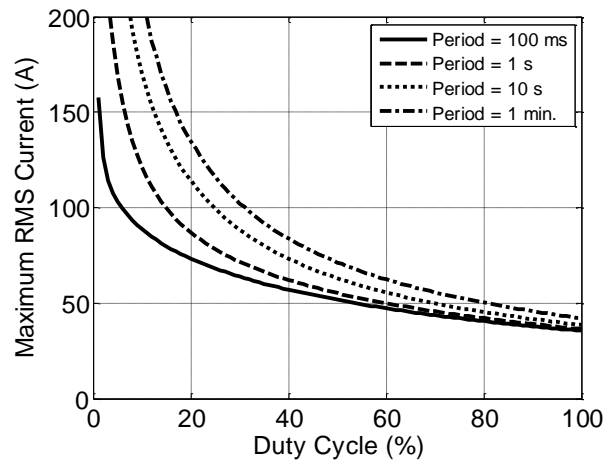

Figure 3: Absolute maximum current for repetitive switching operation (1 second period)

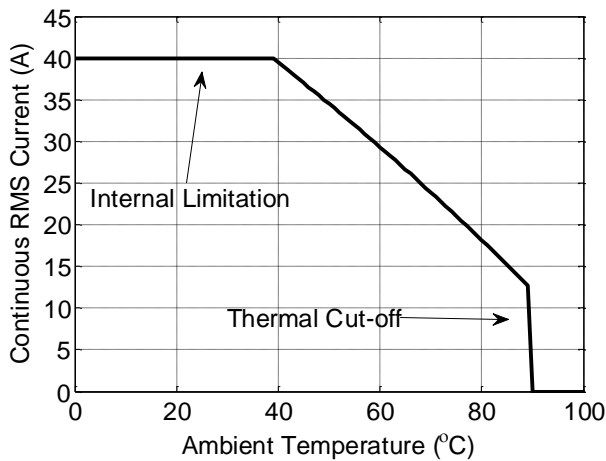

Figure 4: De-rating vs. ambient temperature under continuous operation (Safe operating area)

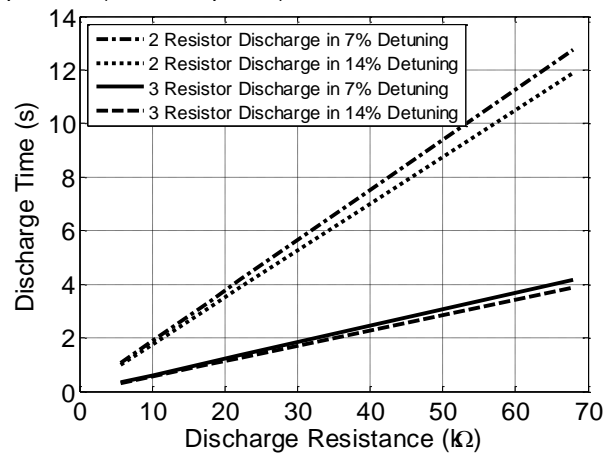

Figure 5: Discharge time vs. discharge resistance

ALPHA-025

Microprocessor-Controlled Capacitor Switching Thyristor Modules
Datasheet



Wiring Diagrams

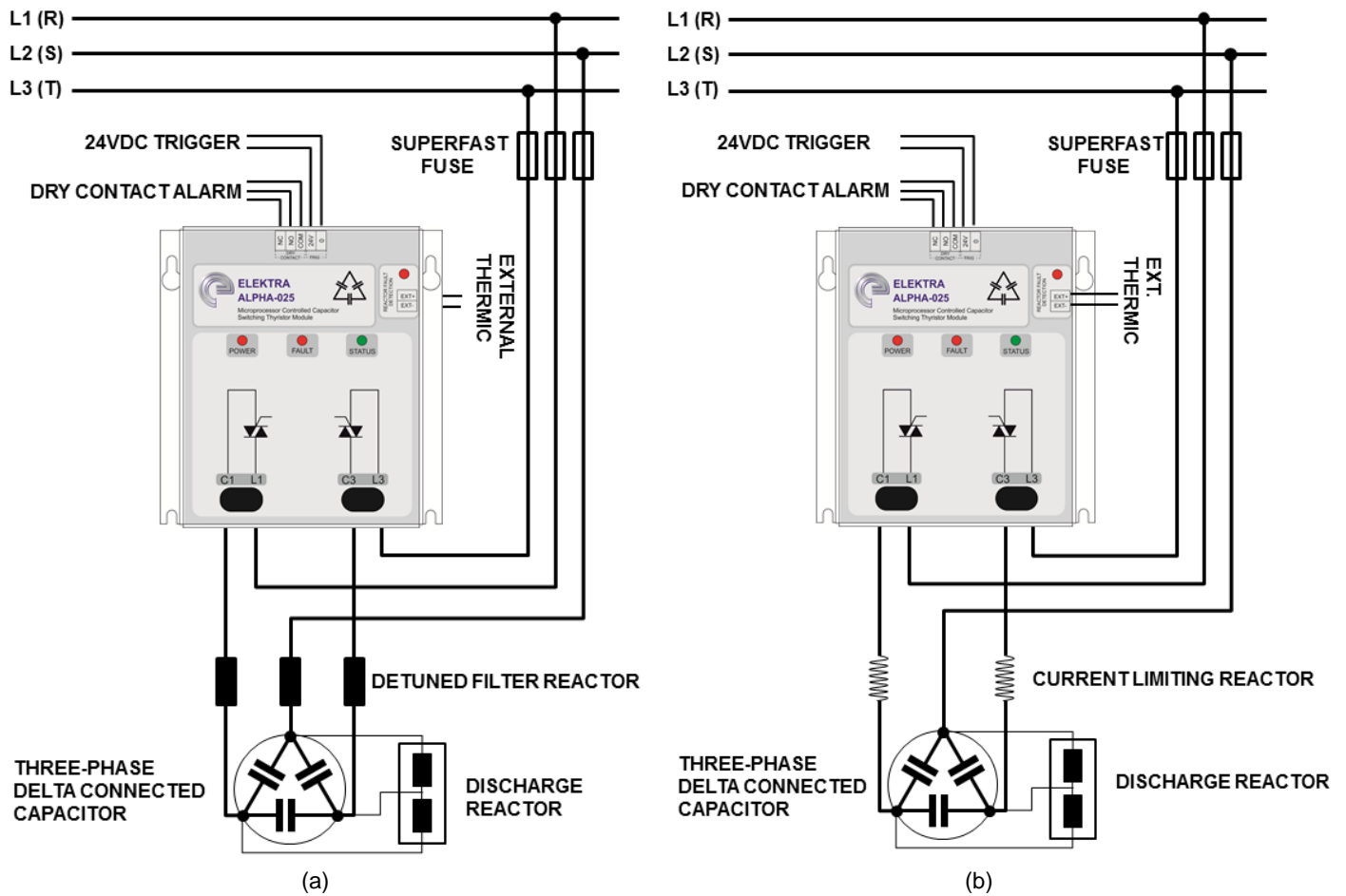

Figure 6: Recommended wiring diagram for ALPHA-025 module (a) with and (b) without a detuned filter reactor. Discharge resistors or reactors (shown) are imperative for frequent repetitive switching.

Drawings

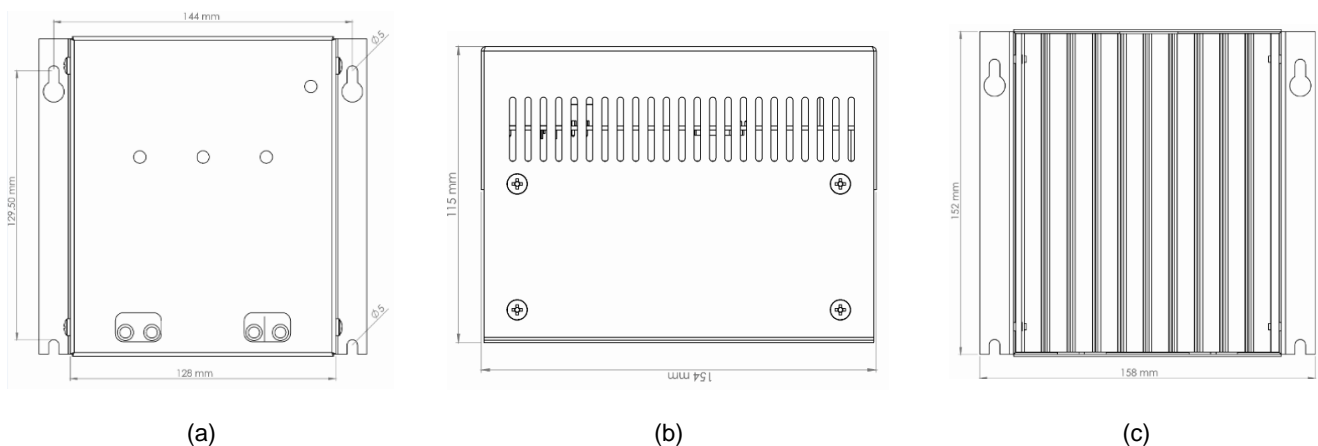

Figure 7: ALPHA-025 module technical drawings

General tolerance is ± 0.5 mm

Cautions

Please follow safety instructions!

- ALPHA modules may only be utilized according to their intended use.
- Appropriate safety measures have to be taken with ALPHA modules, such as using superfast fuses, surge arresters, etc.
- ALPHA modules have to be sufficiently ventilated and protected against dust and humidity.
- ALPHA modules must not be triggered unless all life-threatening risks are eliminated.
- PFC-capacitors may be charged above the peak line-to-line voltage during switch-off transient and stay charged permanently even after they are disconnected.
- In non-detuned systems with 400V grid voltage, 440V capacitors should be used.
- In 7% and 14% detuned systems, 480V and 525V capacitors should be used, respectively!
- High-voltage discharging resistors must be utilized. Standard resistors cannot be used.
- In non-detuned PFC-systems (without reactors) current limiting reactors must be used!
- ALPHA thyristor modules must be protected by superfast electronic fuses.
- Even if the PFC step is switched off, the capacitors remain charged. An appropriate protection against touch must be assured!
- Installation must be done by skilled personnel only.
- Before any assembly or maintenance work is started, all installations and equipment must be disconnected from the power source and assured that the PFC-capacitors are completely discharged.

Noncompliance with these instructions and warnings may lead to death, serious injury or major damage to equipment.
FAILURE TO FOLLOW CAUTIONS MAY RESULT IN FAILURES AND/OR PHYSICAL INJURY.

Terms and Conditions

ALPHA are warranted against manufacturing defects for 1 (one) year. If the modules are used with ELEKTRA detuned filter reactors, then the warranty covers them for 2 (two) years. The modules are out of warranty in case of user error, uses not in accordance with recommended practice presented in this datasheet, internal circuits are tampered with and/or the cover is removed.

The manufacturer is not responsible for:

- Any costs resulting from a failure if the installation, setup, repair, alteration, or ambient conditions of the module do not follow the requirements specified in the documentation delivered with the module and other relevant documentation.
- Modules subjected to misuse, negligence or accident

In no event shall the manufacturer, its suppliers or subcontractors be liable for special, indirect, incidental or consequential damages, losses or penalties. If you have any questions concerning your ALPHA modules, please contact the local distributor or ELEKTRA A.Ş. The technical data, information and specifications are valid at the time of printing. The manufacturer reserves the right to make modifications without prior notice.